

Wall mounted Type

ON/OFF E-Series

Model No. HSU-24HEA03

HSU-24LEA03



⚠ WARNING

This service information is designed for experienced repair technicians only and is not designed for use by the general public. It does not contain warnings or cautions to advise non-technical individuals of potential dangers in attempting to service a product. Products powered by electricity should be serviced or repaired only by experienced professional technicians. Any attempt to service or repair the product or products dealt with in this service information by anyone else could result in serious injury or death.

©2009 (Qingdao Haier Air Conditioner General corp.,Ltd)

All right reserved .Unauthorized copying and distribution is a violation of law

Haier Group



Большая библиотека технической документации

<https://splitsystema48.ru/instrukcii-po-ekspluatacii-kondicionerov.html>

каталоги, инструкции, сервисные мануалы, схемы.

Table of Contents

1. Features	1
2. Specifications	2
3. Remote controller lists	4
4. Sensors lists	4
5. Dimensional drawings	5
6. Operation range	7
7. Piping diagrams	8
8. Wiring diagrams	9
9. Performance curves diagrams	11
10. Sound level	21
11. Accessories	22
12. Control systems	23
13. Center of gravity	24
14. Installations	25

1.Features



Healthy negative ion: make your room full of an abundance natural negative ions



Sleep mode: The setting temperature and the indoor noise can be adjusted to a more comfortable level when you set the "sleep mode" during night sleep



24 Hour timer: Use the timer function to set on, or off, or from on to off, or from off to on



Auto restart: The function permits automatic return to previous operation conditions



Easy clean design: The panel is easy to wash and the airflow vents can be detached without any special tools for quick cleaning of the inside of the air conditioner



Auto mode: According to the fixed temperature "26°C", the unit will adjust the operation mode automatically.



Intelligent air: With twin-blade technology, the airflow can be adjusted not to blow directly to human body, so preventing people from the air conditioner symptom



Child lock: Avoid the child's wrong operation on the remote controller



4 Fan setting: Select the fan speed LO, MED, HI, AUTO



Quick cooling or heating



Lower noise operation condition

2. Specifications

Model			HSU-24LEA03	HSU-24HEA03	
			Cooling	Cooling	Heating
Capacity Rated	kW		7.3	7.3	7.7
	Btu/h		24910	24910	26280
	kcal/h		6270	6270	6622
POWER SUPPLY			VM	VM	VM
NOMINAL DISTRIBUTION SYSTEM VOLTAGE	Phase		1PH	1PH	1PH
	Frequency	HZ	50	50	50
	Voltage	V	220V	220V	220 V
Moisture Removal		L/h	2.6	2.6	2.6
Running Current (Rated)		A	12.5	12.5	12
Power Consumption Rated		W	2600	2600	2700
COP Rated		W/W	2.81	2.81	2.85
Piping Connections (external diameter)	Liquid	mm	φ 9.52		
	Gas	mm	φ 15.88		
	Drain	mm	φ16.0		
Heat Insulation			Both Liquid and Gas Pipes		
Max. Piping Length		m	20		
Max. Level Difference		m	10		
Chargeless		m	5		
Amount of Additional Charge of Refrigerant		g/m	60		
Indoor Unit					
Front Panel Color			Mat Crystal Silver		
Air Flow Rate	m ³ /min(cfm)	H	18.3(647.2)		
		M	16.9(595.4)		
		L	15.4(543.6)		
Fan	Type		Cross Flow Fan		
	Motor Output	W	40		
	Speed	Steps	4 Steps, Auto		
Air Direction Control			Right, Left, Horizontal, Downward		
Air Filter			Removable / Washable / Mildew Proof		
Run current (rated)		A	0.2		
Power consumption		W	45		
Temperature Control			Microcomputer Control		
Dimensions (W×H×D)		mm	1046×299×239		
Packaged Dimensions (W×H×D)		mm	1126×388×344		
Weight		kg	13		
Gross Weight		kg	16.5		
Operation Sound	H/M/L	dBA	47/44/40		
Sound Power	H(cooling/heating)	dBA	47		

Outdoor Unit				
Casing Color		Ivory White		
Compressor	Type		Hermetic motor compressor	
	Model		TOSHIBA PH460X3CS-4MU3	
	Motor Output	W	2565/2640	
	Oil Type		SUNISO 4GSD/MN56EP	
	Oil Charge	L	1.1	
Refrigerant	Model		R22	
	Charge	kg	1.7	2.1
Air Flow Rate (H/L)	m ³ /min		48.6	
	cfm		1716.1	
Fan	Type		Axial fan	
	Motor Output	W	70	
Running current (rated)		A	11.6	11.6 12.1
Power Consumption (rated)		W	2555	2555 2655
Starting Current		A	26	26
Dimensions (W×H×D) (stop valve, and bottom support is not included)		mm	865 x732×335	865 x732×335
Packaged Dimensions (W×H×D)		mm	995 x815×420	995 x815×420
Weight		kg	57	62
Gross Weight		kg	61	66
OperationSound	H	dBA	56	56
Sound Power	H(cooling/heating)	dBA	56	56

Note: The data are based on the conditions shown in the table below.

Cooling	Heating	Piping Length
Indoor: 27°CDB/19°CWB Outdoor: 35°CDB/24°CWB	Indoor: 20°CDB Outdoor: 7°CDB/6°CWB	5m

Conversion Formulae

kcal/h=kW×860
Btu/h=kW× 3413
cfm=m³/min×35.3

3 Remote controller lists

Model	HSU-24LEA03	HSU-24HEA03
YL-H04	Y	
YR-H04		Y

4 Sensors lists

INDOOR UNIT		
type	Description	Qty
Room sensor	It's used for detecting room temperature	1
Pipe sensor	It's used for detecting temperature of evaporator	1

5 dimensional drawings

Indoor unit

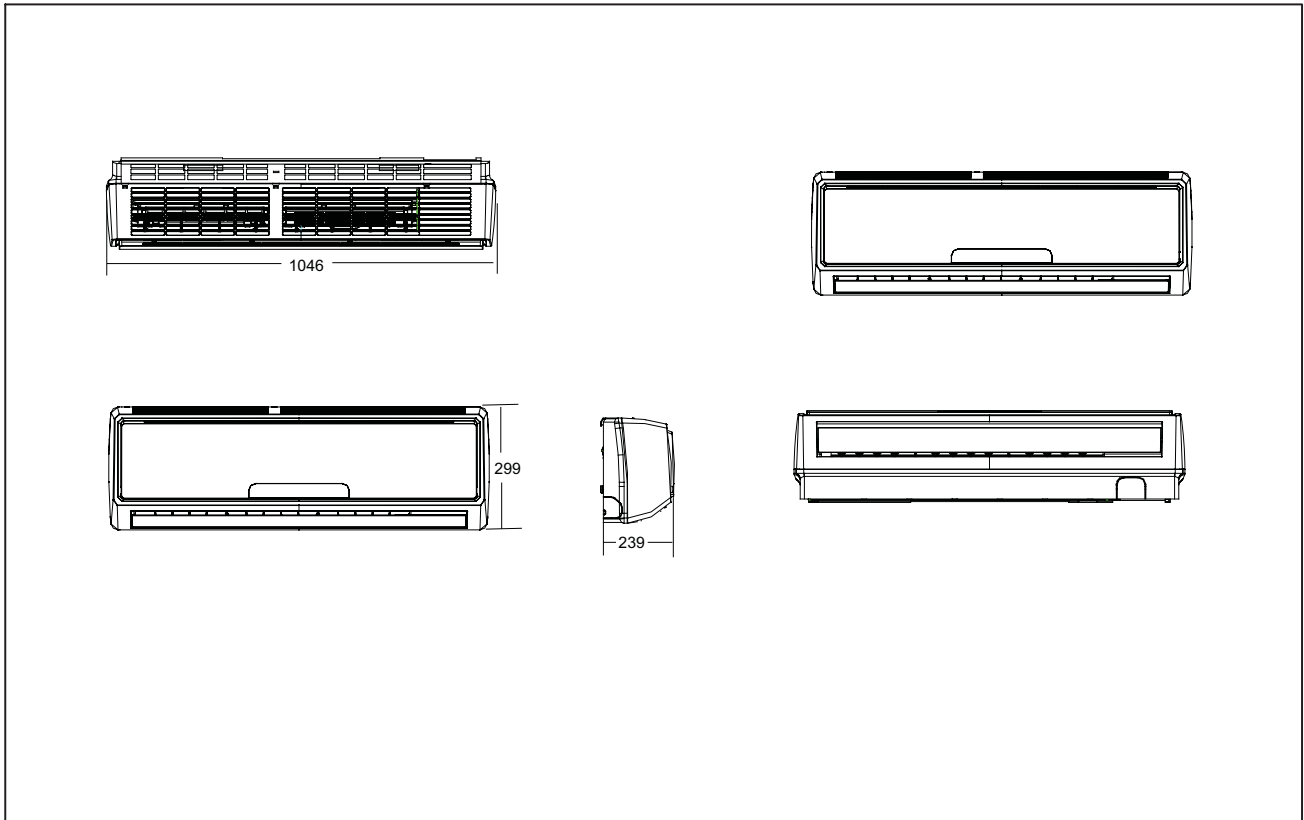

Outdoor unit

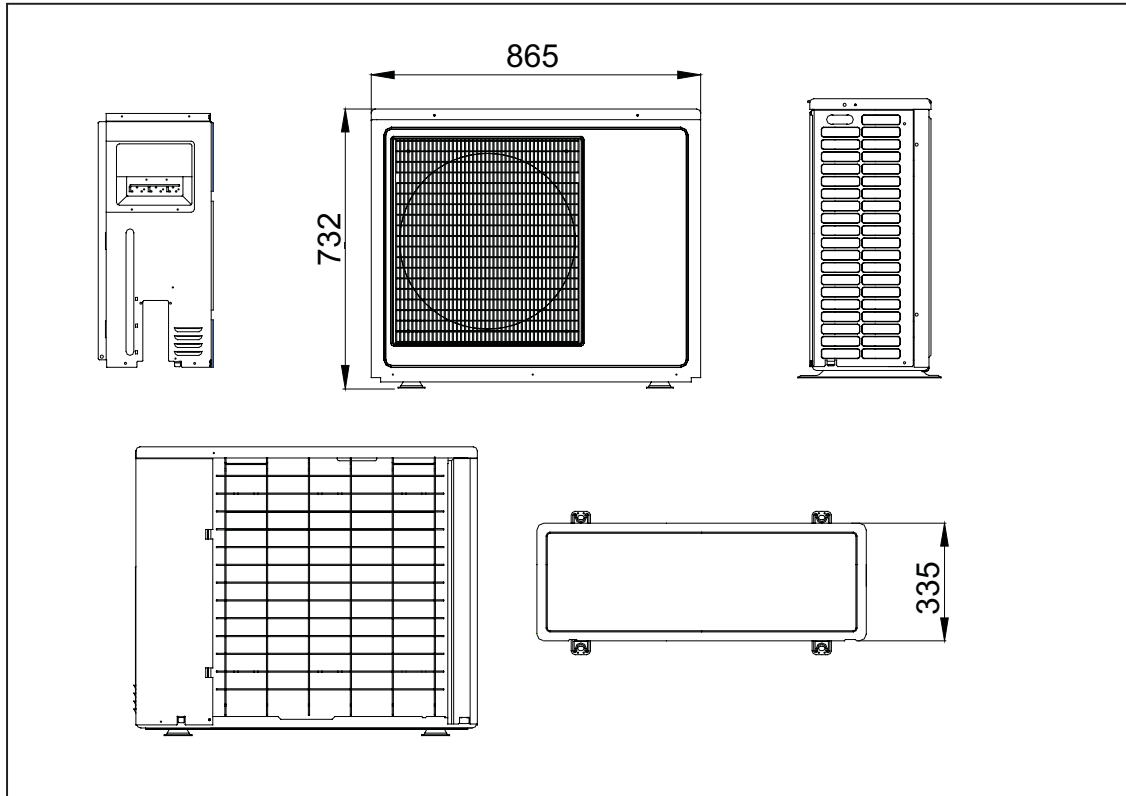

6 Operation range

Cooling

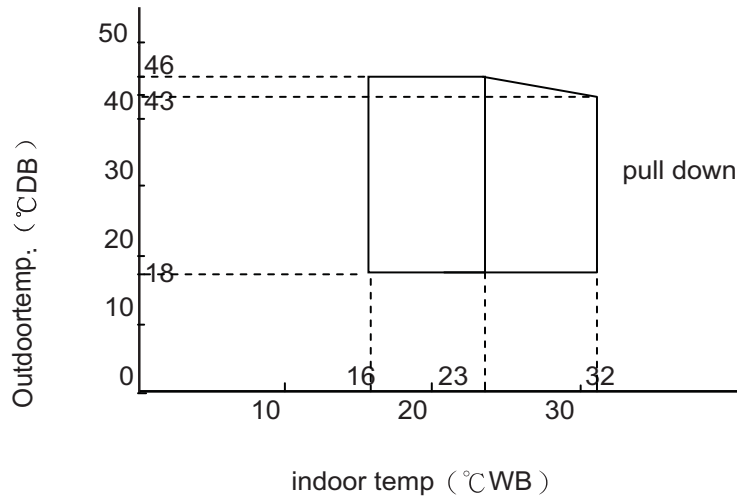

Heating

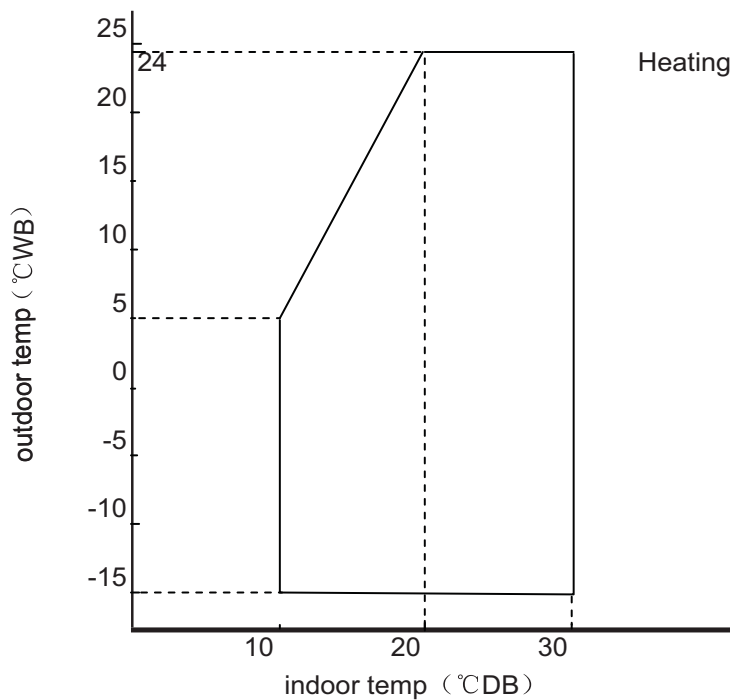

Notes:

The graphs are based on the following condition:

Equivalent piping length	7.0m
Level difference	0m
Air flow rate	high

7 Piping diagrams

Cooling mode

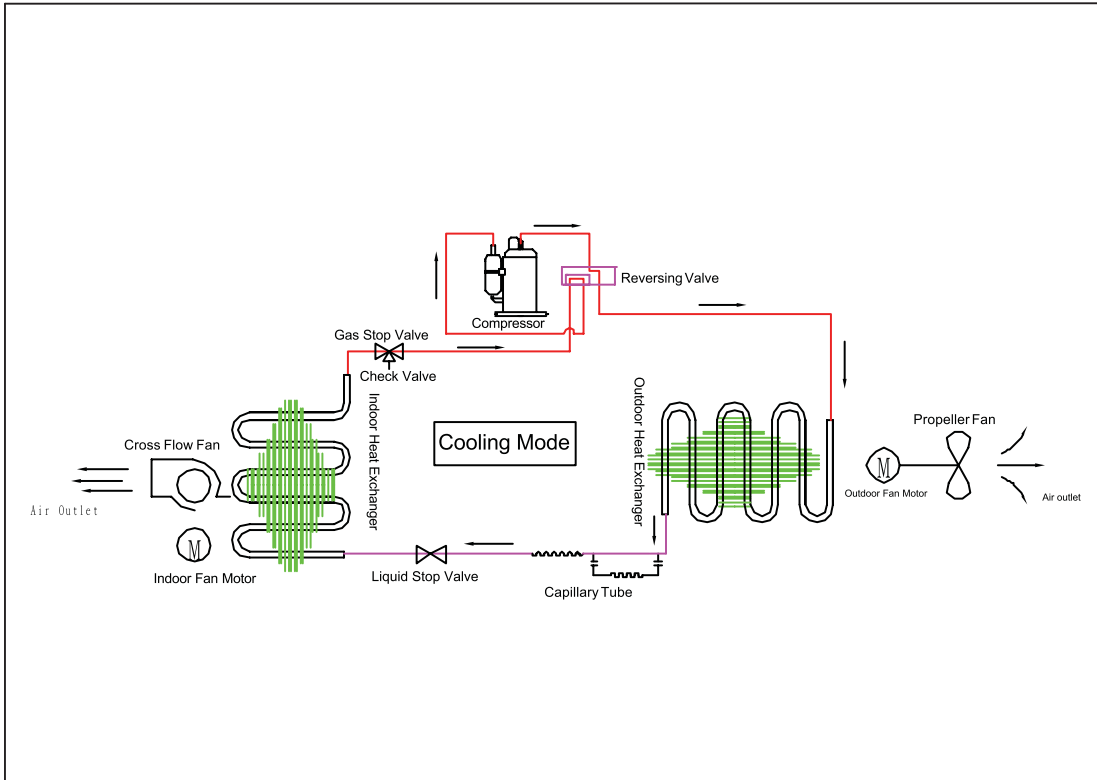

Heating mode

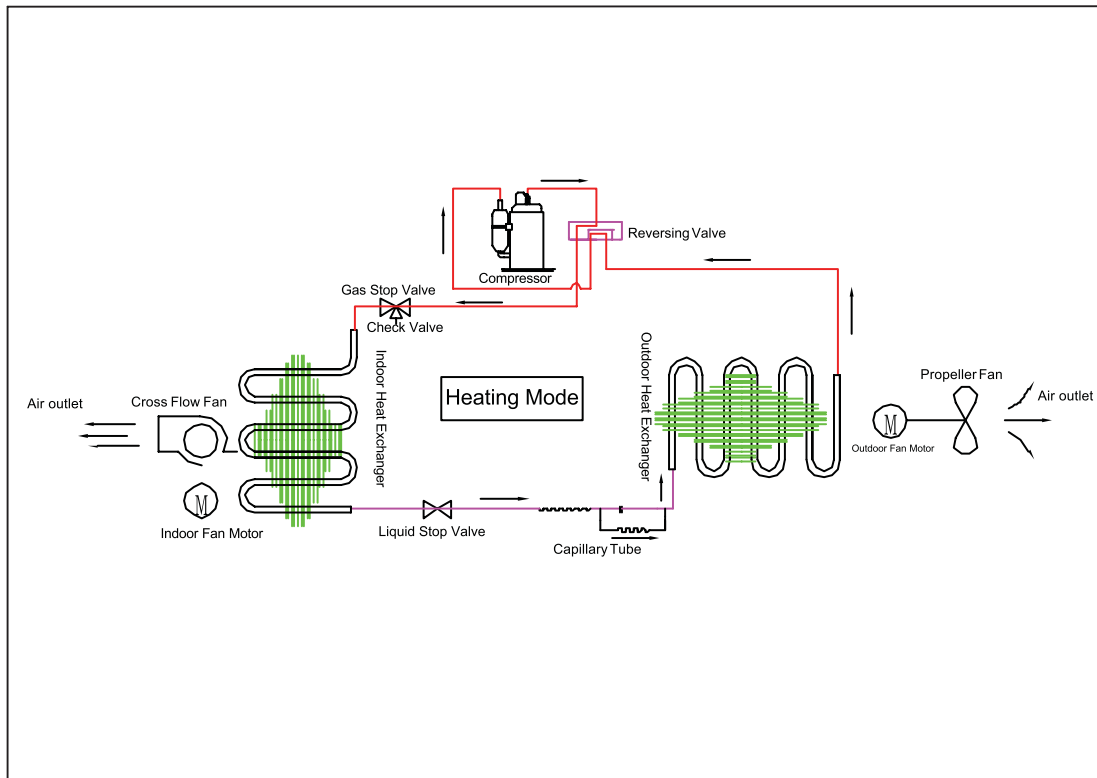

8 Wiring diagrams

Indoor

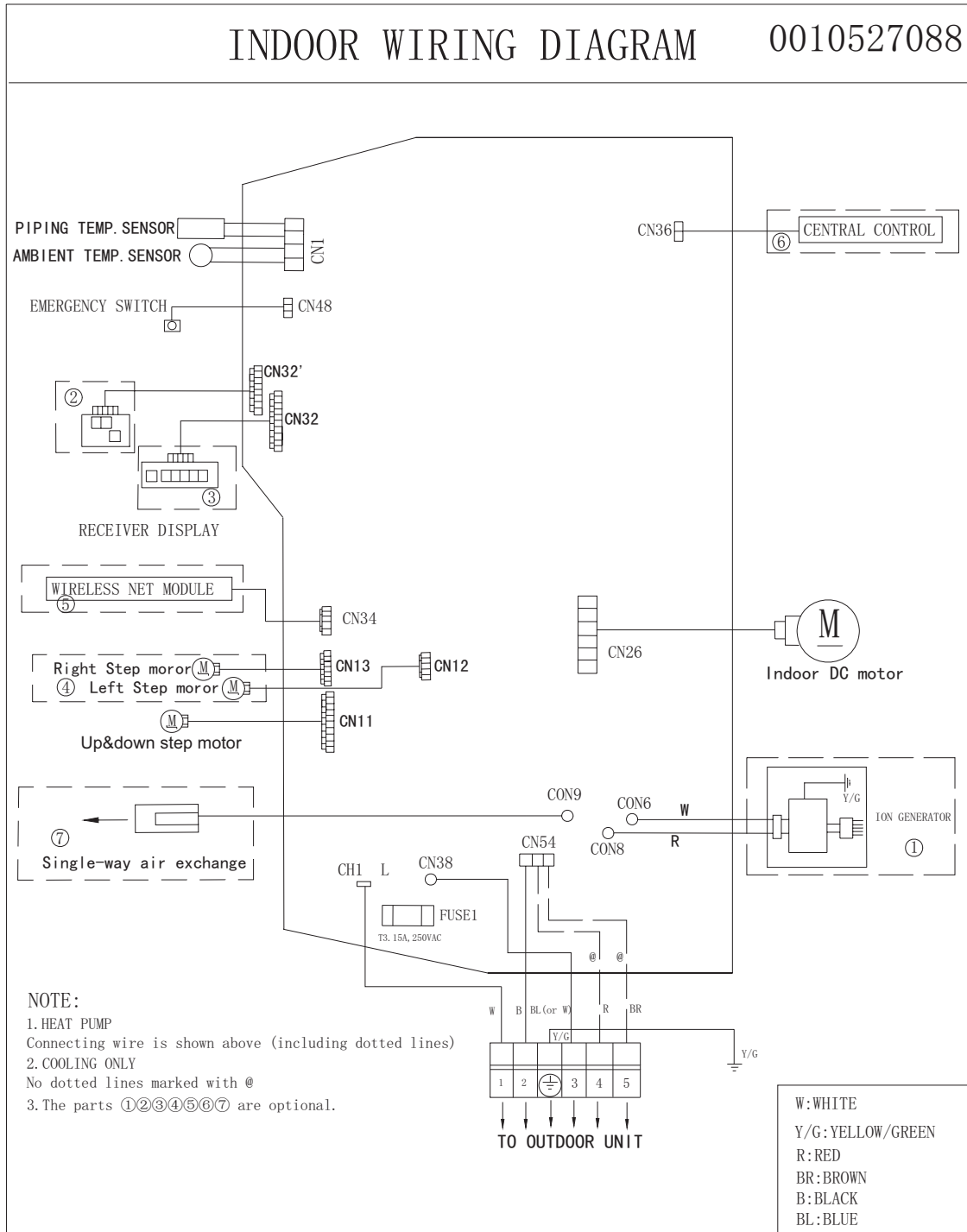

Outdoor

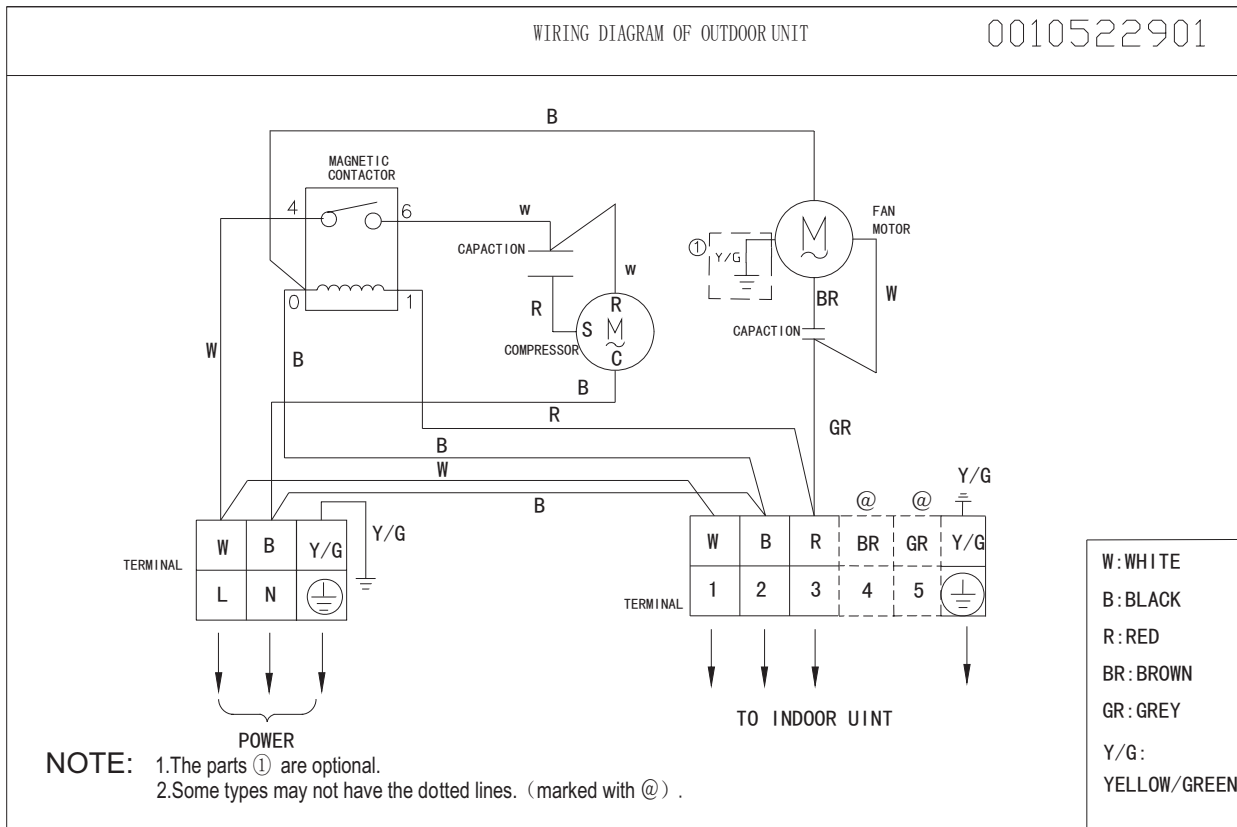

9 Performance Curves Diagram

9.1 Heating Capacity-temperature Curves

HSU-24L/HEA03 performance curves								
cooling value-temperature talbe								
indoor temp	outdoor temp.(humidity 46%)							
DB/WB	18°C	20°C	25°C	32°C	35°C	40°C	43°C	46°C
18/12°C	6486	6497	6507	6286	6296	6339	6189	5973
18/14°C	6969	6980	7047	6795	6758	6628	6516	6330
20/15°C	7451	7464	7477	7382	7220	7059	6923	6687
22/16°C	7397	7413	7430	7362	7187	6981	6842	6677
25/18°C	7344	7363	7382	7341	7154	6968	6845	6649
27/19°C	7605	7515	7565	7402	7300	7149	7026	6802
30/22°C	7882	7734	7922	7628	7498	7368	7196	7049
32/23°C	7982	7718	7928	7599	7542	7433	7305	7077
32/24°C	8061	7792	8006	7671	7613	7501	7370	7140

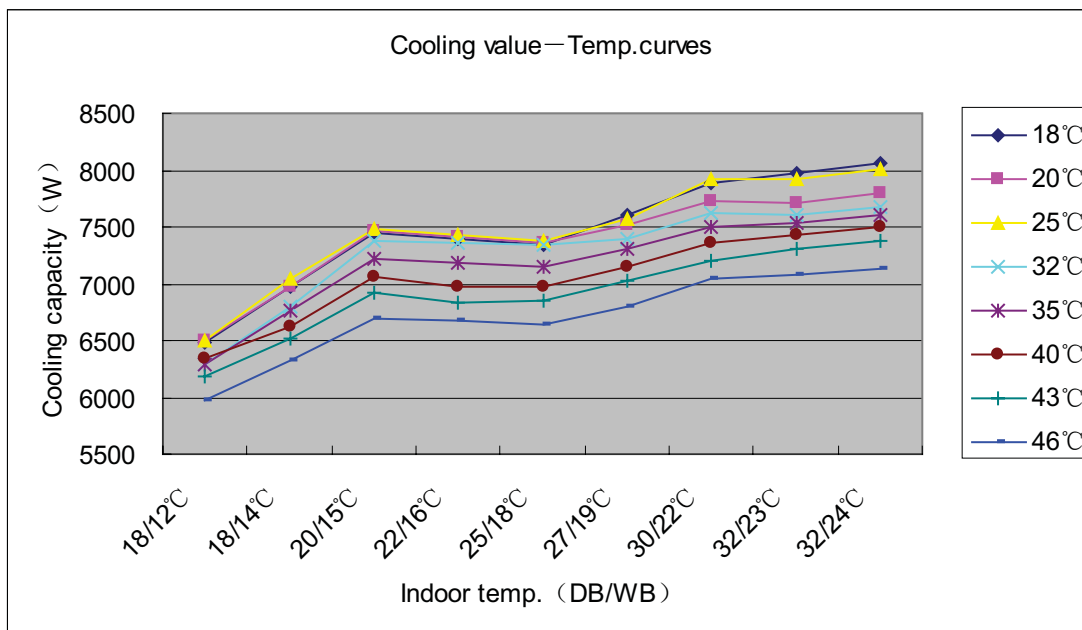

9.2 Sensible Cooling Value-temperature Curves

HSU-24L/HEA03 performance curves								
sensible cooling value-temperature table								
indoor temp	outdoor temp.(humidity 46%)							
DB/WB	18°C	20°C	25°C	32°C	35°C	40°C	43°C	46°C
18/12°C	4540	4548	4555	4400	4407	4437	4332	4181
18/14°C	4878	4886	4933	4757	4731	4639	4561	4431
20/15°C	5216	5225	5234	5167	5054	4941	4846	4681
22/16°C	5178	5189	5201	5153	5031	4887	4789	4674
25/18°C	5141	5154	5167	5139	5008	4877	4791	4654
27/19°C	5323	5260	5295	5181	5110	5004	4918	4762
30/22°C	5517	5413	5546	5340	5249	5157	5037	4934
32/23°C	5587	5403	5549	5319	5280	5203	5113	4954
32/24°C	5643	5454	5604	5370	5329	5251	5159	4998

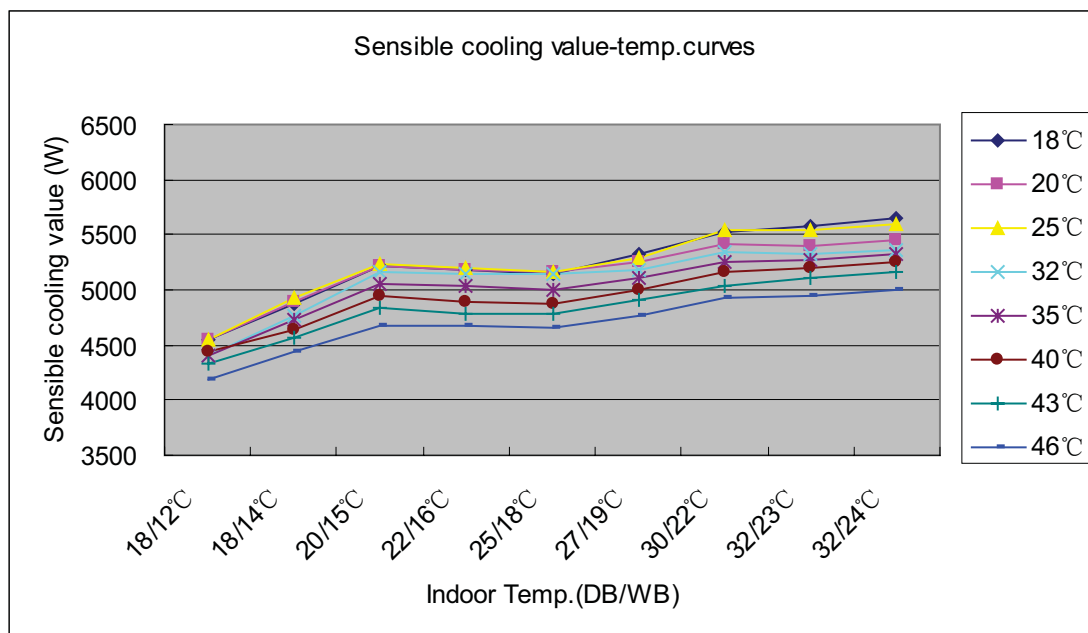

9.3 Cooling Power Consumption Value-temperature Curves

HSU-24L/HEA03 performance curves								
power consumption value-temperature								
indoor temp.	outdoor temp.(humidity 46%)							
DB/WB	18°C	20°C	25°C	32°C	35°C	40°C	43°C	46°C
18/12°C	2188	2196	2211	2308	2435	2655	2711	2766
18/14°C	2262	2270	2287	2394	2534	2776	2837	2898
20/15°C	2363	2342	2330	2531	2562	2697	2774	2852
22/16°C	2366	2344	2331	2547	2570	2698	2777	2857
25/18°C	2368	2346	2332	2562	2578	2699	2780	2861
27/19°C	2386	2363	2350	2585	2600	2724	2807	2890
30/22°C	2405	2382	2368	2607	2623	2749	2834	2919
32/23°C	2411	2374	2347	2566	2602	2747	2844	2941
32/24°C	2430	2384	2356	2577	2614	2760	2858	2956

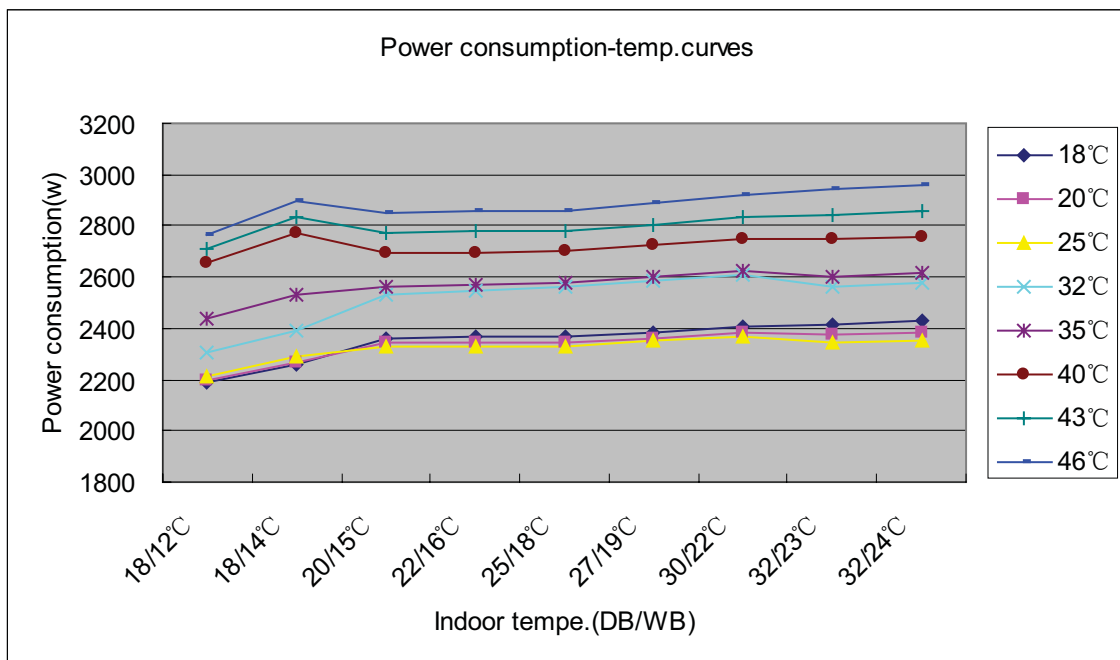

9.4 Heating Capacity-temperature Curves

HSU-24HEA03 performance curves			
heating capacity and indoor/outdoor temp.curves			
outdoor temp.	indoor temp.(humidity 46%)		
DB/WB	15°C	20°C	25°C
-15°C	5545	5472	5375
-5°C	6384	6298	6175
5°C	6786	6694	6569
7/6°C	7299	7700	6828
15°C	7800	7850	7600
20°C	8100	8000	7900
25°C	8600	8350	8100

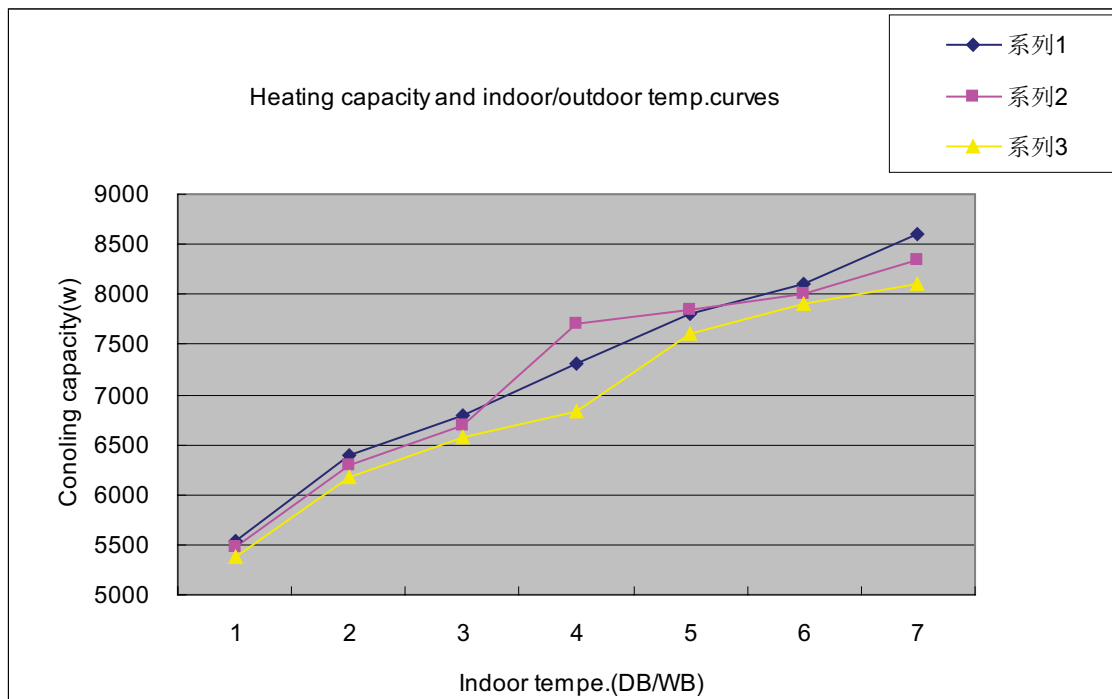

9.5 Heating Power Consumption Value-temperature Curves

HSU-24HEA03 performance curves			
power consumption value-temp.talbe			
outdoor temp.	indoor temp.(humidity 46%)		
DB/WB	15°C	20°C	25°C
-15°C	2456	2499	2536
-5°C	2531	2610	2647
5°C	2542	2609	2666
7/6°C	2670	2700	2718
15°C	2752	2786	2806
20°C	2560	2629	2707
25°C	2469	2556	2623

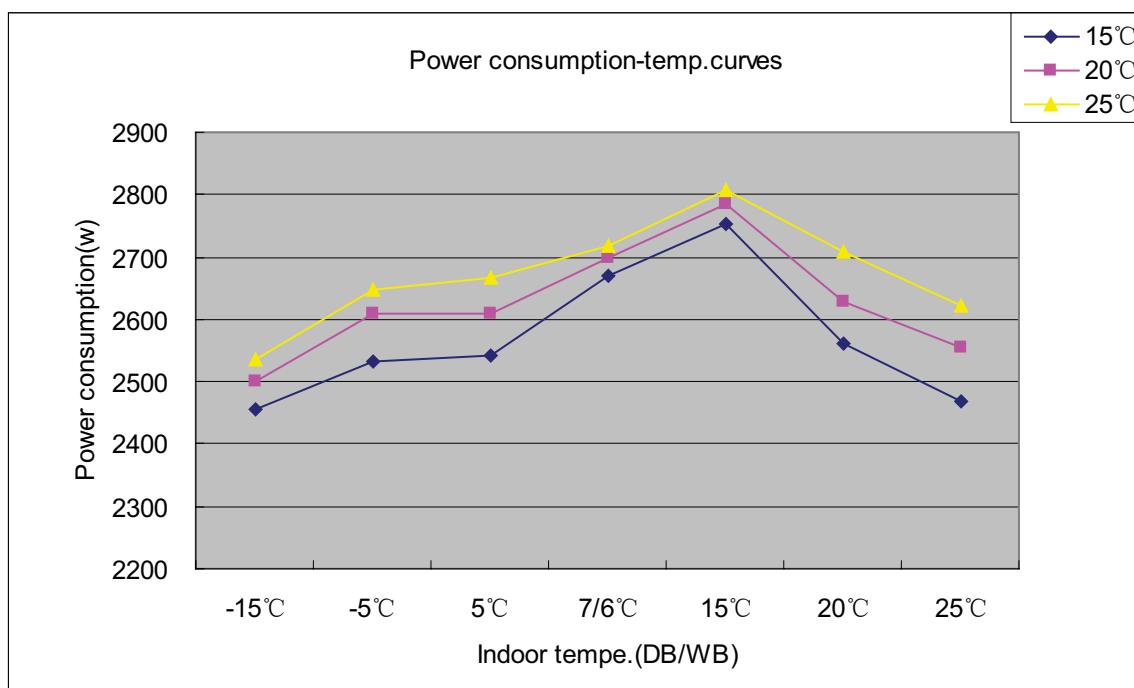

9.6 Air outlet Value-temperature Curves

HSU-24L/HEA03 performance curves								
air outlet temp.-ambient teme.talbe								
indoor temp	outdoor temp.(humidity 46%)							
DB/WB	18°C	20°C	25°C	32°C	35°C	40°C	43°C	46°C
18/12°C	4.81	4.70	4.47	5.31	5.25	5.30	5.81	6.18
18/14°C	5.26	5.16	4.90	5.83	5.77	5.81	6.37	6.78
20/15°C	9.08	8.97	8.54	9.04	9.64	10.32	10.65	10.97
22/16°C	9.32	9.20	9.05	9.31	9.91	10.60	10.99	11.29
25/18°C	9.57	9.44	9.26	9.57	10.19	10.89	11.34	11.61
27/19°C	11.25	11.10	10.89	11.28	12.10	12.82	13.35	13.69
30/22°C	13.17	13.12	13.06	13.68	14.18	14.78	15.15	15.33
32/23°C	15.07	15.17	15.24	16.07	16.36	16.74	16.95	16.97
32/24°C	15.37	15.47	15.54	16.40	16.69	17.08	17.28	17.32

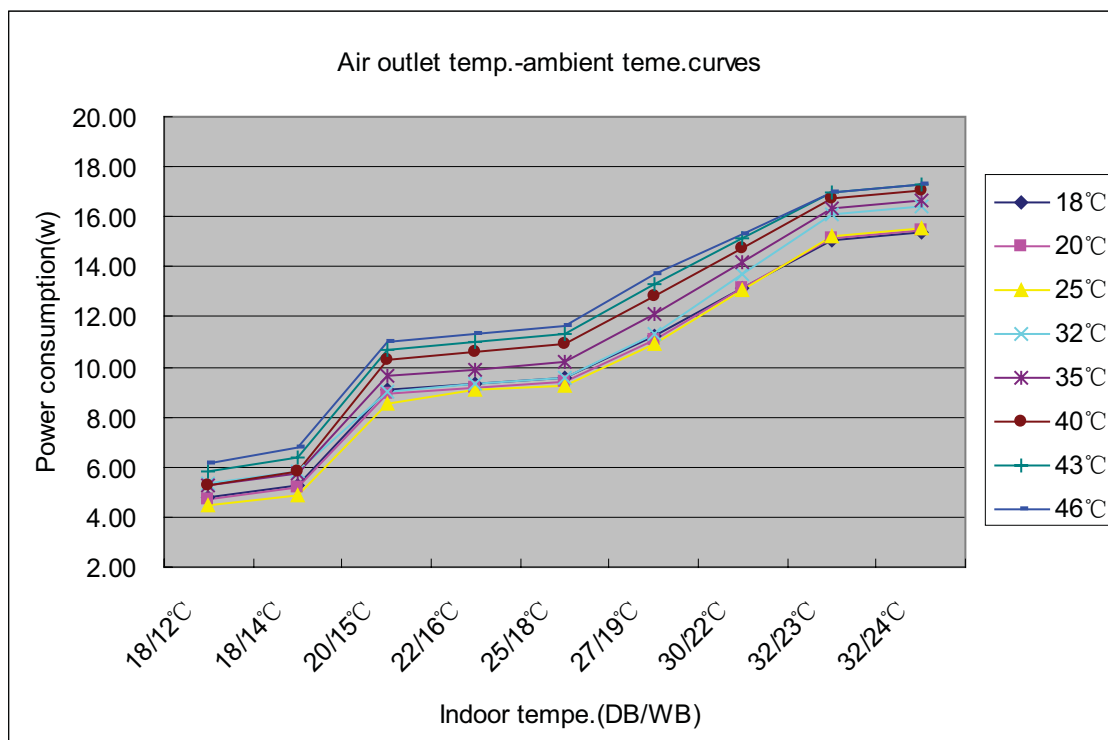

9.7 Cooling Discharge Pressure Curves

HSU-24LEA03 performance curves			
cooling discharge pressure table			
outdoor temp. (humidity 46%)	indoor temp.		
	16°C	19°C	22°C
DB/WB			
15°C	2052	2256	2336
25°C	2078	2210	2321
30°C	2451	2623	2694
35°C	2764	2891	2970
40°C	3075	3156	3247
45°C	3430	3600	3640

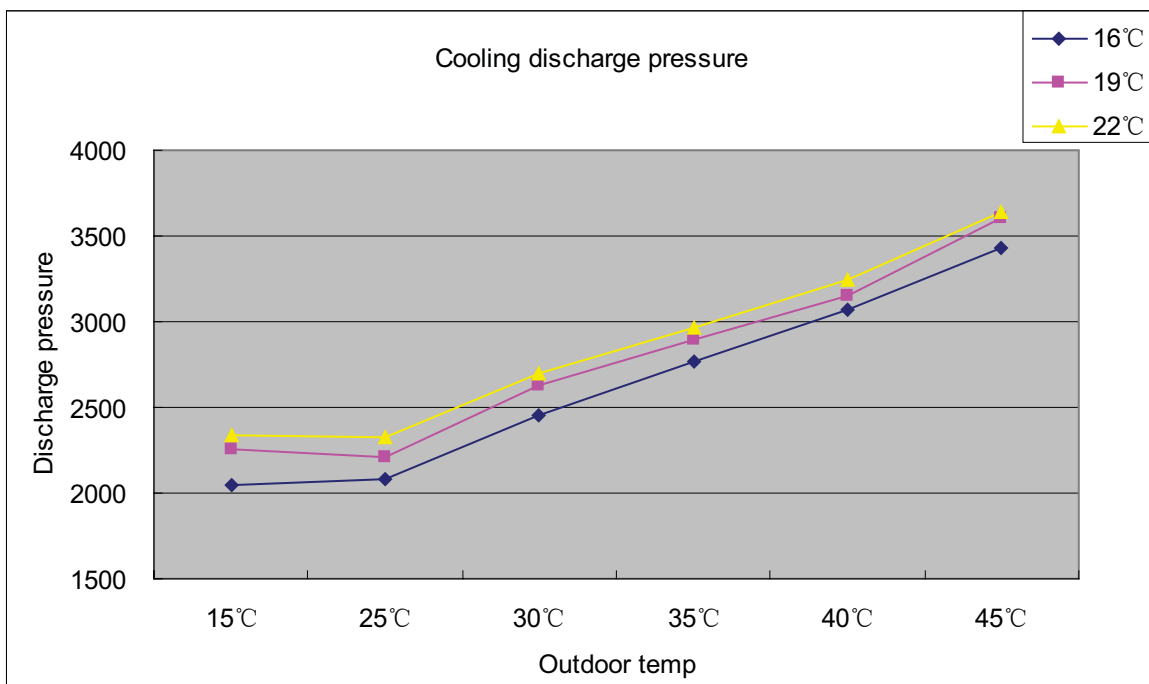

9.8 Heating Discharge Pressure Curves

HSU-24HEA03 performance curves			
heating discharge pressure table			
outdoor temp. (humidity 46%)	indoor temp.		
	15°C	20°C	25°C
DB/WB			
−15°C	2106	2274	2439
−10°C	2172	2363	2585
−5°C	2427	2543	2752
0°C	2393	2563	2764
5°C	2552	2733	2858
10°C	2920	3065	3370
15°C	3419	3602	3670
20°C	3060	3433	3603

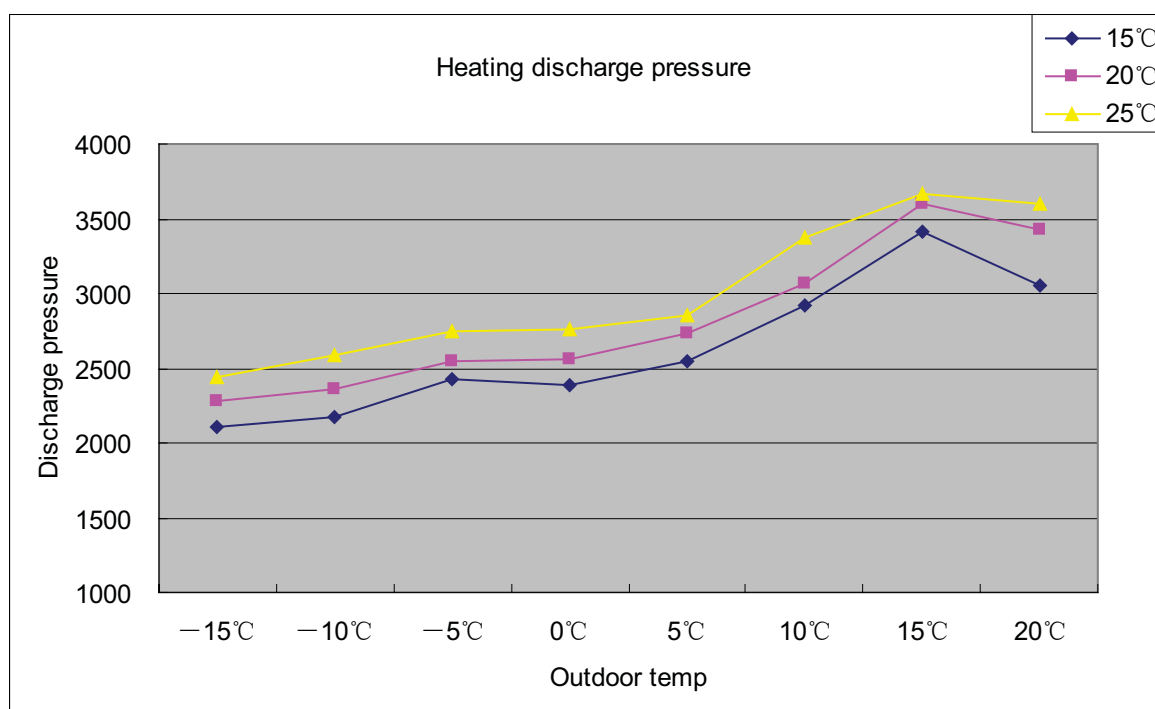

9.9 Cooling Suction Pressure Curves

HSU-24LEA03 performance curves			
cooling suction pressure.talbe			
outdoor temp. (humidity 46%)	indoor temp.		
	16°C	19°C	22°C
15°C	665	752	764
25°C	693	772	776
30°C	696	776	775
35°C	706	780	796
40°C	744	822	838
45°C	771	854	868

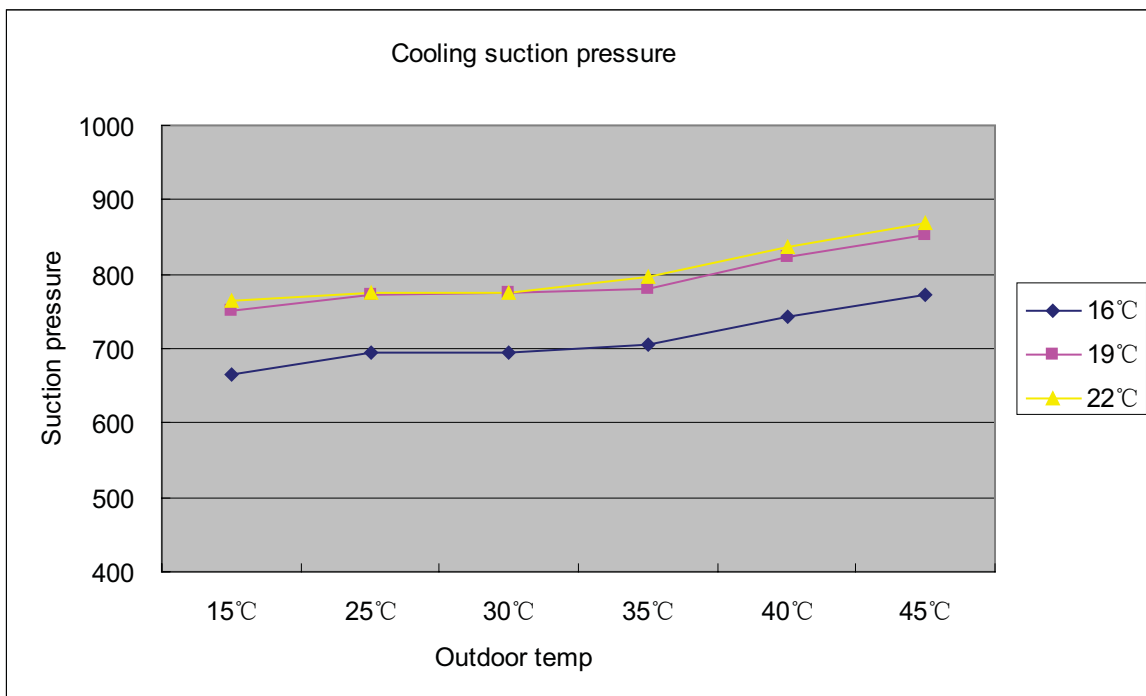

10.0 Heating Suction Pressure Curves

HSU-24HEA03 performance curves			
heating suction pressure.talbe			
outdoor temp. (humidity 46%)	indoor temp.		
DB/WB	15°C	20°C	25°C
-15°C	260	259	262
-10°C	325	330	340
-5°C	394	415	420
0°C	430	470	478
5°C	470	540	545
10°C	600	648	682
15°C	757	757	818
20°C	719	749	762

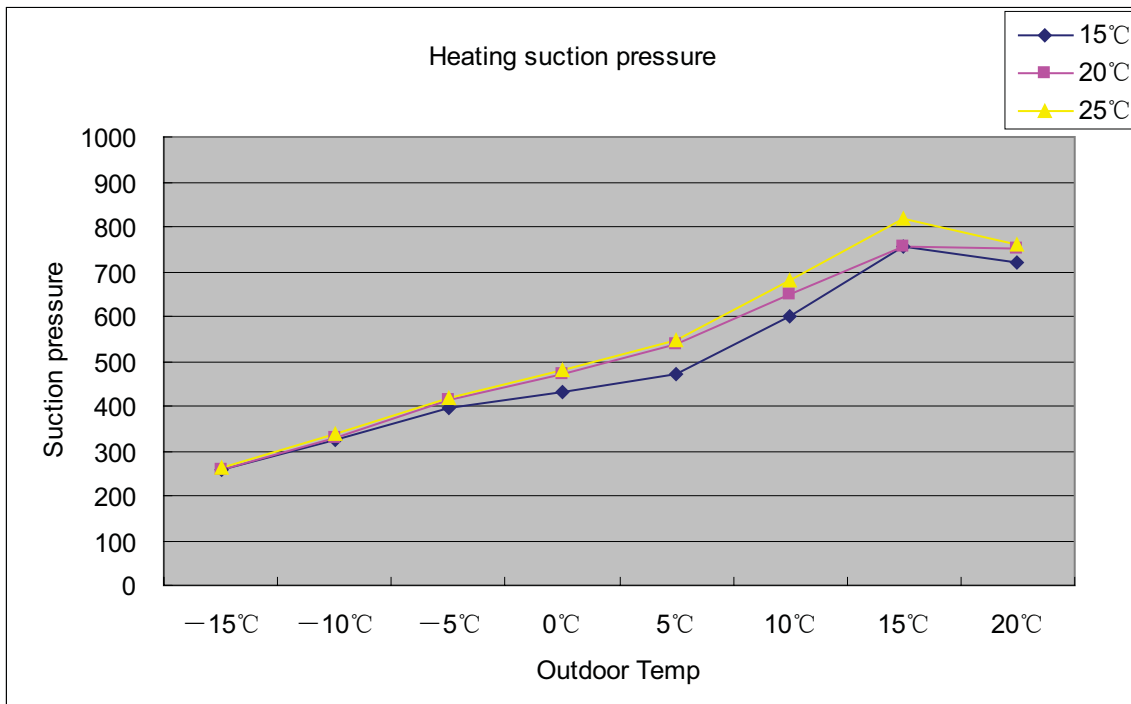

10 Sound level

HSU-24L/HEA03

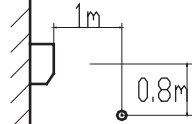
Model	Sound pressure level			Measuring location Location of microphone 	sound power level (cooling/heating)
	220V,50Hz				
	Cooling/heating				
	H	L	SL		
HSU-24L/HEA03	47	44	40		56

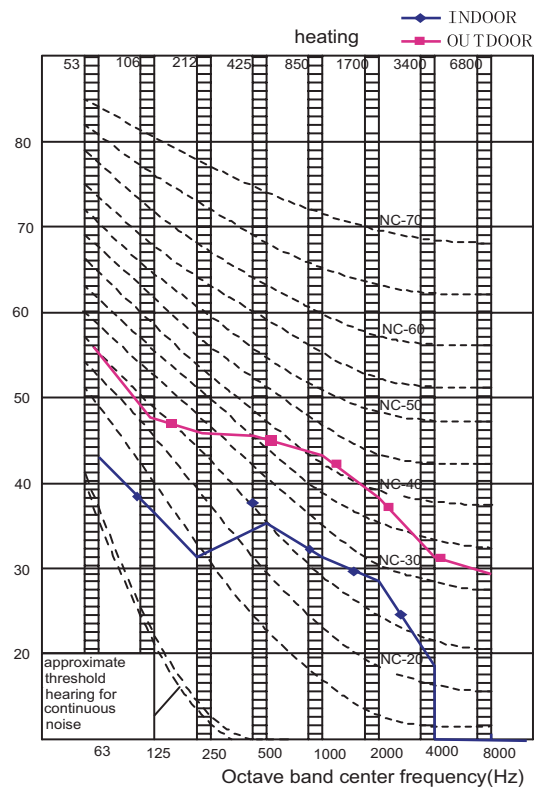
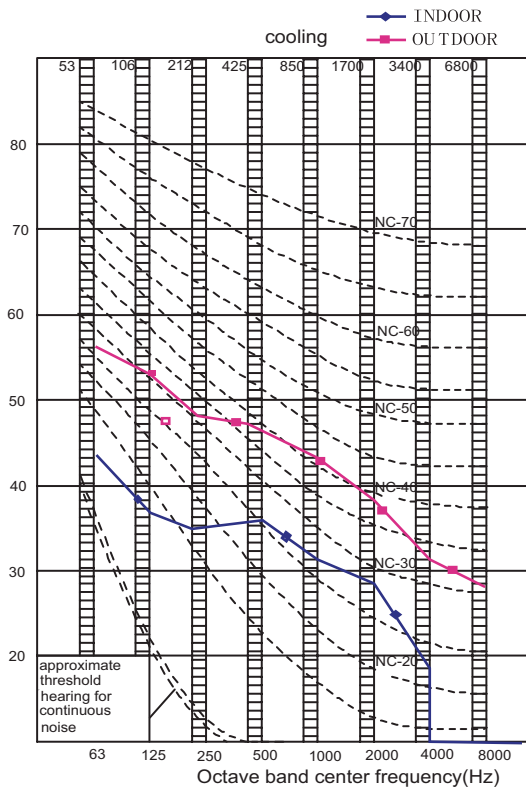

11 Accessories

Standard accessories

Standard name	HSU-24LEA03	HSU-24HEA03
Drain hose	1	1
Plastic bag	1	1
screw assembly	1	1
Air purifier	2	2
Change for fresh airtube(suit)	1	1
Mounting plate	1	1
Remote controller	1	1
Installation manual	1	1
Operation manual	1	1
R-03 dry battery	2	2
Steel nail	6	6
Plastic cap	4	4
Cover	1	1
Cushion	4	4
Pipe supporting plate	1	1
Drain elbow	0	1

12 Control systems

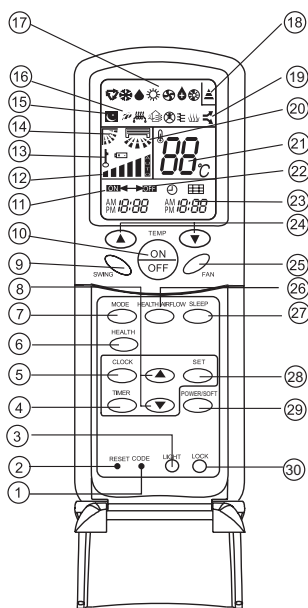

- 1. CODE
Used to select CODE A or B with a press, A or B will be displayed on LCD. Please select A without special explanation.
- 2. RESET
When the remote controller appears abnormal, use a sharp pointed article to press this button to reset the remote controller normal.
- 3. LIGHT button
Control the lightening and extinguishing of the indoor LED display board.
- 4. TIMER button
Used to select TIMER ON, TIMER OFF, TIMER ON-OFF.
- 5. CLOCK button
Used to set correct time.

- 6. HEALTH button
Used to set healthy operation.
 - 7. MODE button
 - 8. HOUR button
Used to set clock and timer setting.
 - 9. SWING button
Used to select up or down air sending direction.
 - 10. ON/OFF button
Used for unit start and stop.
 - 11. TIMER ON display
 - 12. FAN SPEED display
 - 13. LOCK display
 - 14. SWING UP/DOWN display
 - 15. SLEEP display
 - 16. HEALTH display
 - 17. Operation mode display
- | Operation mode | AUTO | COOL | DRY | HEAT | FAN |
|-------------------|------|------|-----|------|-----|
| Remote controller | | | | | |
| Display board | | | | | |

- 18. Signal sending display
- 19. POWER/SOFT display
- 20. Left/right air flow display
- 21. TEMP display
Remote controller: to display the TEMP. setting.
- 22. TIMER OFF display
- 23. CLOCK display
- 24. TEMP button
Used to select your desired temperature.
- 25. FAN button
Used to select fan speed: LOW, MED, HI, AUTO.
- 26. HEALTH AIRFLOW button
Used to set the health airflow mode.
- 27. SLEEP button
Used to select sleep mode.
- 28. SET button
Used to confirm timer and clock settings.
- 29. POWER/SOFT button
Use to set power/soft function.
- 30. LOCK
Used to lock buttons and LCD display. If pressed, the other buttons will be disabled and the lock condition display appears. Press it once again, lock will be cancelled and lock condition display disappears.

If the unit which you purchased has SWING LEFT/RIGHT function, follow it. If not, please ignore.

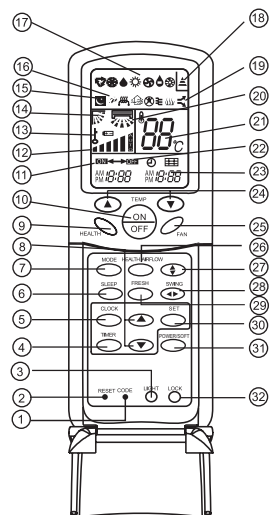

- 1. CODE
Used to select CODE A or B with a press, A or B will be displayed on LCD. Please select A without special explanation.
- 2. RESET
When the remote controller appears abnormal, use a sharp pointed article to press this button to reset the remote controller normal.
- 3. LIGHT button
Control the lightening and extinguishing of the indoor LED display board.
- 4. TIMER button
Used to select TIMER ON, TIMER OFF, TIMER ON-OFF.
- 5. CLOCK button
Used to set correct time.
- 6. SLEEP button
Used to select sleep mode.
- 7. MODE button

- 8. HOUR button
Used to set clock and timer setting.
 - 9. HEALTH button
Used to set healthy function.
 - 10. ON/OFF button
Used for unit start and stop.
 - 11. TIMER ON display
 - 12. FAN SPEED display
 - 13. LOCK display
 - 14. SWING UP/DOWN display
 - 15. SLEEP display
 - 16. HEALTH display
 - 17. Operation mode display
- | Operation mode | AUTO | COOL | DRY | HEAT | FAN |
|-------------------|------|------|-----|------|-----|
| Remote controller | | | | | |
| Display board | | | | | |
- 18. Signal sending display
 - 19. POWER/SOFT display
 - 20. Left/right air flow display
 - 21. TEMP display
Remote controller: to display the TEMP. setting.
 - 22. TIMER OFF display
 - 23. CLOCK display
 - 24. TEMP button
Used to select your desired temperature.
 - 25. FAN button
Used to select fan speed: LOW, MED, HI, AUTO.
 - 26. HEALTH AIRFLOW button
Used to set the health airflow mode.
 - 27. SWING UP/DOWN button
Used to select up or down air sending direction.
 - 28. SWING LEFT/RIGHT button
Used to select left/right air flow.
 - 29. FRESH button
Use to set fresh air function. (This function is unavailable on this models.)
 - 30. SET button
Used to confirm timer and clock settings.
 - 31. POWER/SOFT button
Used to set power/soft function.
 - 32. LOCK
Used to lock buttons and LCD display. If pressed, the other buttons will be disabled and the lock condition display appears. Press it once again, lock will be canceled and lock condition display disappears.

NOTE:

Cooling only unit do not have displays and functions related with heating
If the unit which you purchased has healthy function, follow it. If not, please ignore.

13 Center of gravity

Indoor unit

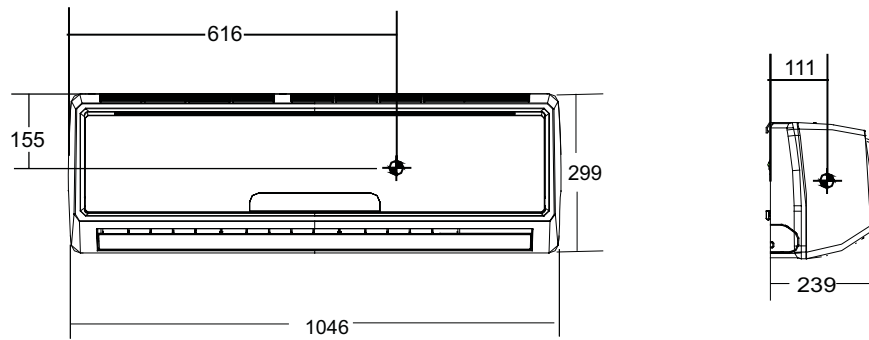

Outdoor unit

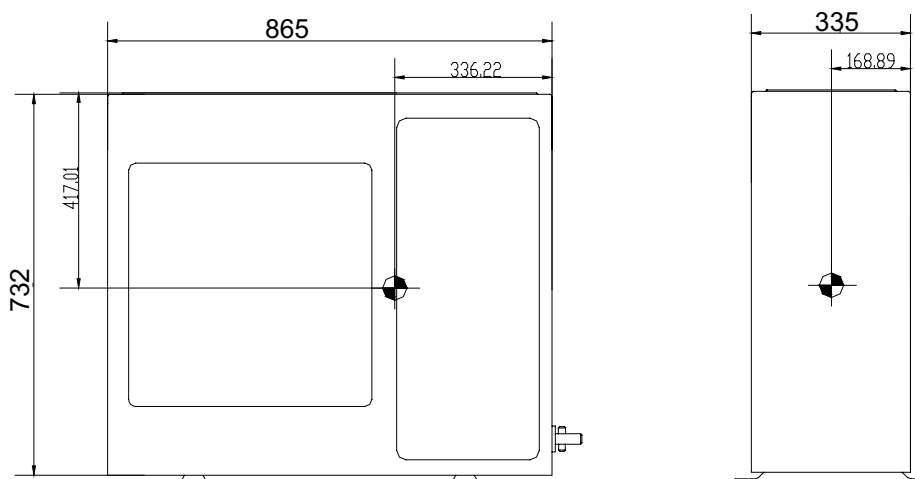

14 Installation

Drawing for the installation of indoor and outdoor units

Optional parts for piping

Mark	Parts name
(A)	Non-adhesive tape
(B)	Adhesive tape
(C)	Saddle(L.S) with screws
(D)	Connecting electric cable for indoor and outdoor
(E)	Drain hose
(F)	Heating insulating material
(G)	Piping hole cover

Accessory parts

No.	Accessory parts	Number of articles
①	Remote controller	1
②	R-03 dry battery	2
③	Mounting plate	1
④	Drain hose	1
⑤	Steel nail, cement	6
⑥	Plastic cap	4
⑦	Cover	1
⑧	Cushion	4
⑨	Pipe supporting plate	1
⑩	Drain-elbow	1

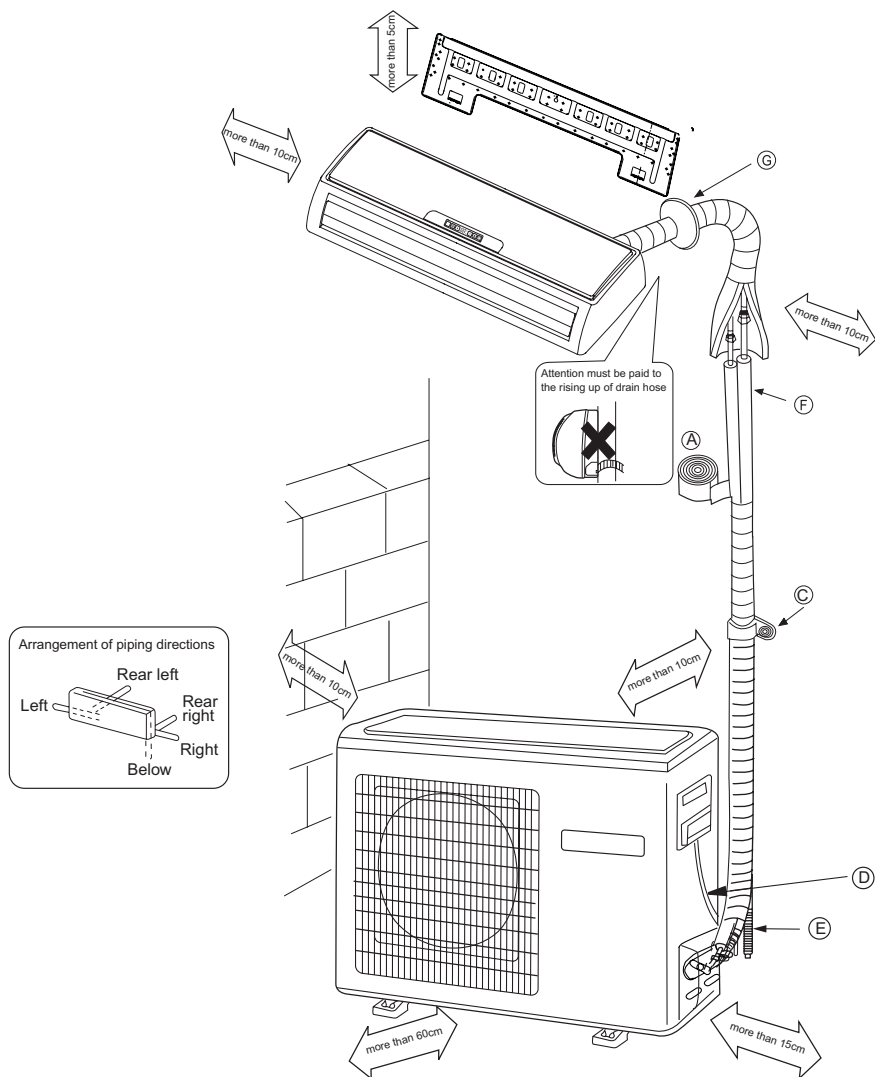

※ The marks from (A) to (G) in the figure are the parts numbers.

※ The distance between the indoor unit and the floor should be more than 2m.

Sincere Forever

Haier Group

Haier Industrial Park, No.1, Haier Road

266101, Qingdao, China_

E-mail: hractech@haier.com

Tel: +86 532 87636960

[Http://www.haier.com](http://www.haier.com)

Edited by : Liu Suping
Wang Zhihao

Signed by : Yang Bifei

Approved by: Wu Hongjin



Большая библиотека технической документации

<https://splitsystema48.ru/instrukcii-po-ekspluatacii-kondicionerov.html>

каталоги, инструкции, сервисные мануалы, схемы.